

Standard Preparation 2000 mm Work Table with Upstand

ITEM # _____

MODEL # _____

NAME # _____

SIS # _____

AIA # _____

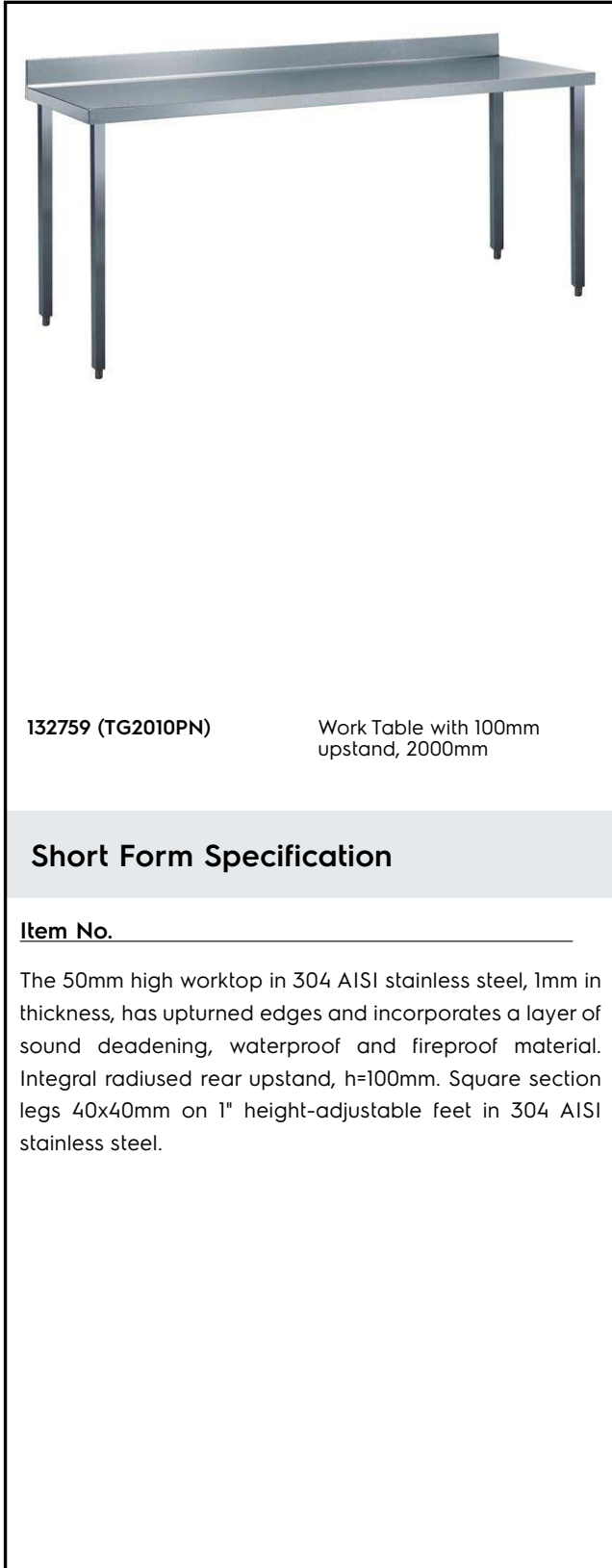

132759 (TG2010PN)

 Work Table with 100mm
upstand, 2000mm

Short Form Specification

Item No.

The 50mm high worktop in 304 AISI stainless steel, 1mm in thickness, has upturned edges and incorporates a layer of sound deadening, waterproof and fireproof material. Integral radiused rear upstand, h=100mm. Square section legs 40x40mm on 1" height-adjustable feet in 304 AISI stainless steel.

Main Features

- The table can be ordered with the drawer of 400 mm or 600 mm (optional accessory): thanks to the design of the drawer, additional drawers can be added to the first single drawer to create chest of 2, 3 or 4 drawers based on customer's needs.
- Sturdiness, stability and reliability of table accurately tested.

Construction

- 50 mm worktop in 304 AISI stainless steel, 10/10 in thickness with upturned edges and reinforced waterproof underpanel, incorporates a layer of sound deadening materials.
- Square section legs and 40 mm height-adjustable feet in 304 AISI stainless steel.
- Table top slots into legs without using screws to facilitate installation.
- 400 or 600 mm wide single drawer, chest of 4 drawers, lower shelf, three-sided underframe and set of castors as alternative to the feet, can be fitted as optional on all work tables.
- 40 mm-thick lower shelf (available as optional accessory on some models) slots easily into place at a height of 200 mm from the floor. Lower shelf is compulsory to install the chest of drawers.
- Delivered in knock-down package.
- 100 mm upstand with 10 mm radiused corner and 13 mm deep, designed to be used against a wall.

Optional Accessories

- Lower shelf for 2000mm tables and sinks PNC 855149
- Set of 4 wheels (2 with brake) d. 100mm for tables and sinks (total height on wheels= 993 mm) PNC 855150
- 3-sided underframe for 2000mm tables PNC 855156
- Single drawer GN 1/1, 400mm PNC 855280
- Single drawer, 600mm PNC 855281
- Additional drawer, 600mm (to set up a chest of 2, 3, 4 drawers) PNC 855295
- Additional drawer GN 1/1, 400mm (to set up a chest of 2, 3, 4 drawers) PNC 855298

APPROVAL: _____

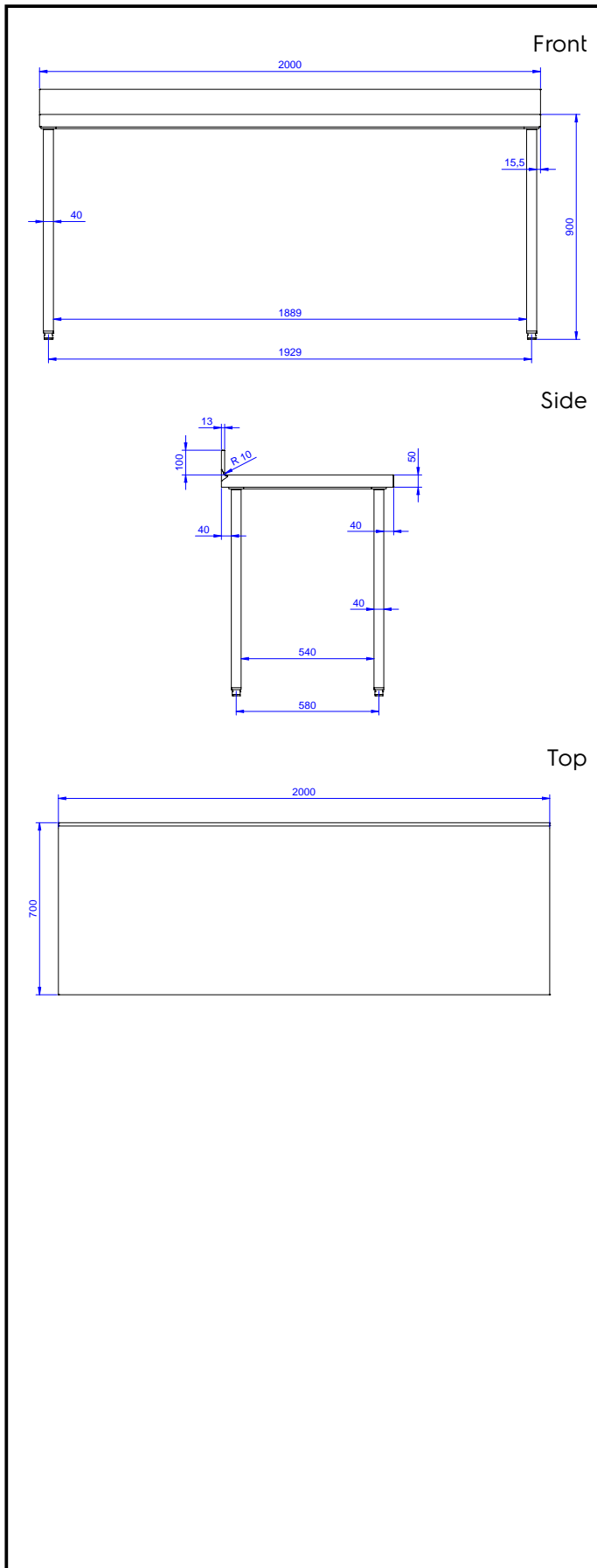

Key Information:

External dimensions, Width:	2000 mm
132759 (TG2010PN)	2000 mm
External dimensions, Depth:	700 mm
External dimensions, Height:	1000 mm
Upstand Dimensions, Height:	100 mm
Upstand Dimensions, Depth:	13 mm
Upstand Dimensions, Radius:	R=10
Worktop thickness:	50 mm
Net weight:	58 kg